

Golden Retriever - ゴールデンレトリバー -

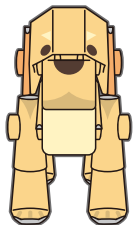

必要なもの_Required Tools

用意するものはハサミだけ！ノリは使いません。
Only tool required is scissors. No glue or tape needed!



ポイント_Tips

以下の点に注意しながら、パイプを組み立てていきます。
Follow the tips below and assemble the pipes as shown.

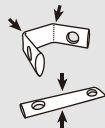

点線は谷折り
Fold inward along the dotted lines.

平たくつぶしてから曲げる
Flatten the piece for easier folding.

カット図_Cutting Diagram

切り取り線にそってハサミで切り、全てのパーツを切り離します。
Cut the pipes along the white lines.

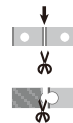

★印の付いたパイプは穴部分の端を切り離します。
For pipes marked with ★, cut off the edge of the hole as shown.



▲ハサミの取り扱いには十分ご注意ください。Please handle scissors with care.

body & legs

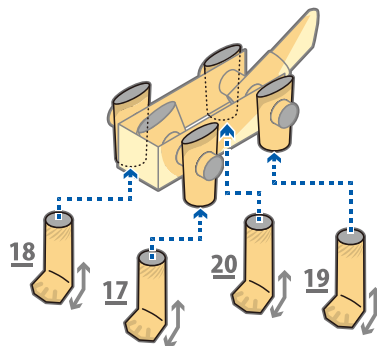
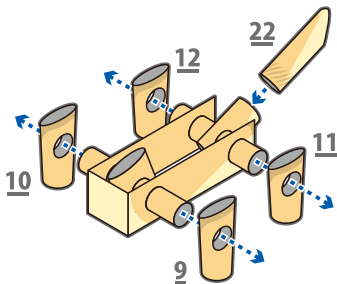
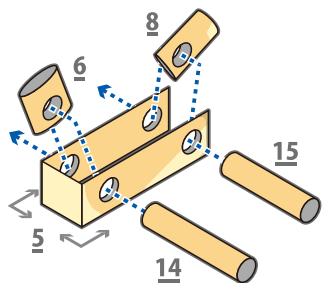

head & ears

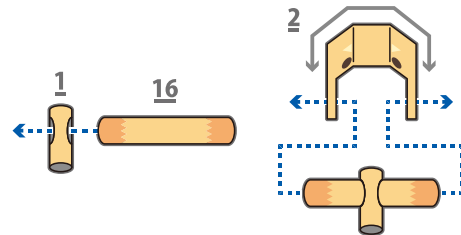

head & body

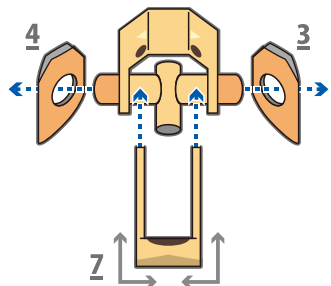

finish

